

Netz-Thyristor
Phase Control Thyristor
T1190N
Elektrische Eigenschaften / Electrical properties
 Höchstzulässige Werte / Maximum rated values

Periodische Vorwärts- und Rückwärts-Spitzensperrspannung repetitive peak forward off-state and reverse voltages	$T_{vj} = -40^{\circ}\text{C} \dots T_{vj \max}$	$V_{\text{DRM}}, V_{\text{RRM}}$	1200 1400	1600 1800	V V
Vorwärts-Stosspitzensperrspannung non-repetitive peak forward off-state voltage	$T_{vj} = -40^{\circ}\text{C} \dots T_{vj \max}$	V_{DSM}	1200 1400	1600 1800	V V
Rückwärts-Stosspitzensperrspannung non-repetitive peak reverse voltage	$T_{vj} = +25^{\circ}\text{C} \dots T_{vj \max}$	V_{RSM}	1300 1500	1700 1900	V V
Durchlassstrom-Grenzeffektivwert maximum RMS on-state current		I_{TRMSM}		2800	A
Dauergrenzstrom average on-state current	$T_C = 85^{\circ}\text{C}$	I_{TAVM}		1190	A
Dauergrenzstrom average on-state current	$T_C = 55^{\circ}\text{C}, \theta = 180^{\circ}\sin, t_p = 10 \text{ ms}$	I_{TAVM}		1760	A
Durchlaßstrom-Effektivwert RMS on-state current		I_{TRMS}		2770	A
Stossstrom-Grenzwert surge current	$T_{vj} = 25^{\circ}\text{C}, t_p = 10 \text{ ms}$ $T_{vj} = T_{vj \max}, t_p = 10 \text{ ms}$	I_{TSM}		25500 22500	A A
Grenzlastintegral I^2t -value	$T_{vj} = 25^{\circ}\text{C}, t_p = 10 \text{ ms}$ $T_{vj} = T_{vj \max}, t_p = 10 \text{ ms}$	I^2t		3250 2530	$10^3 \text{ A}^2\text{s}$ $10^3 \text{ A}^2\text{s}$
Kritische Stromsteilheit critical rate of rise of on-state current	DIN IEC 60747-6 $f = 50 \text{ Hz}, i_{\text{GM}} = 1 \text{ A}, di_{\text{G}}/dt = 1 \text{ A}/\mu\text{s}$	$(di_{\text{T}}/dt)_{\text{cr}}$		200	A/ μs
Kritische Spannungssteilheit critical rate of rise of off-state voltage	$T_{vj} = T_{vj \max}, V_{\text{D}} = 0,67 V_{\text{DRM}}$ 5.Kennbuchstabe / 5 th letter F	$(dv_{\text{D}}/dt)_{\text{cr}}$		1000	V/ μs

Charakteristische Werte / Characteristic values

Durchlassspannung on-state voltage	$T_{vj} = T_{vj \max}, i_{\text{T}} = 5,4 \text{ kA}$ $T_{vj} = T_{vj \max}, i_{\text{T}} = 1,0 \text{ kA}$	V_{T}	max. max.	2,05 1,06	V V
Schleusenspannung threshold voltage	$T_{vj} = T_{vj \max}$	$V_{(\text{TO})}$		0,90	V
Ersatzwiderstand slope resistance	$T_{vj} = T_{vj \max}$	r_{T}		0,190	m Ω
Durchlasskennlinie 300 A $\leq i_{\text{T}} \leq 6000 \text{ A}$ on-state characteristic $v_{\text{T}} = A + B \cdot i_{\text{T}} + C \cdot \ln(i_{\text{T}} + 1) + D \cdot \sqrt{i_{\text{T}}}$	$T_{vj} = T_{vj \max}$	A= B= C= D=		7,528E-01 1,682E-04 -1,035E-02 6,509E-03	
Zündstrom gate trigger current	$T_{vj} = 25^{\circ}\text{C}, V_{\text{D}} = 12 \text{ V}$	I_{GT}	max.	250	mA
Zündspannung gate trigger voltage	$T_{vj} = 25^{\circ}\text{C}, V_{\text{D}} = 12 \text{ V}$	V_{GT}	max.	2	V
Nicht zündender Steuerstrom gate non-trigger current	$T_{vj} = T_{vj \max}, V_{\text{D}} = 12 \text{ V}$ $T_{vj} = T_{vj \max}, V_{\text{D}} = 0,5 V_{\text{DRM}}$	I_{GD}	max. max.	20 10	mA mA
Nicht zündende Steuerspannung gate non-trigger voltage	$T_{vj} = T_{vj \max}, V_{\text{D}} = 0,5 V_{\text{DRM}}$	V_{GD}	max.	0,2	V
Haltestrom holding current	$T_{vj} = 25^{\circ}\text{C}, V_{\text{D}} = 12 \text{ V}$	I_{H}	max.	500	mA
Einraststrom latching current	$T_{vj} = 25^{\circ}\text{C}, V_{\text{D}} = 12 \text{ V}, R_{\text{GK}} \geq 10 \Omega$ $i_{\text{GM}} = 1 \text{ A}, di_{\text{G}}/dt = 1 \text{ A}/\mu\text{s}, t_{\text{g}} = 20 \mu\text{s}$	I_{L}	max.	2500	mA
Vorwärts- und Rückwärts-Sperrstrom forward off-state and reverse current	$T_{vj} = T_{vj \max}$ $V_{\text{D}} = V_{\text{DRM}}, V_{\text{R}} = V_{\text{RRM}}$	$i_{\text{D}}, i_{\text{R}}$	max.	150	mA
Zündverzug gate controlled delay time	DIN IEC 60747-6 $T_{vj} = 25^{\circ}\text{C}, i_{\text{GM}} = 1 \text{ A}, di_{\text{G}}/dt = 1 \text{ A}/\mu\text{s}$	t_{gd}	max.	4	μs

prepared by:	H.Sandmann	date of publication:	2008-09-18
approved by:	M.Leifeld	revision:	2.0

Netz-Thyristor
Phase Control Thyristor
T1190N
Elektrische Eigenschaften / Electrical properties
 Charakteristische Werte / Characteristic values

Freiwerdezeit circuit commutated turn-off time	$T_{vj} = T_{vj\ max}$, $i_{TM} = I_{TAVM}$ $V_{RM} = 100\ V$, $V_{DM} = 0,67\ V_{DRM}$ $dv_D/dt = 20\ V/\mu s$, $-di_T/dt = 10\ A/\mu s$ 4.Kennbuchstabe / 4 th letter O	t_q	typ. 240 μs
---	--	-------	------------------

Thermische Eigenschaften / Thermal properties

Innerer Wärmewiderstand thermal resistance, junction to case	<u>Kühlfläche / cooling surface</u> beidseitig / two-sided, $\theta = 180^\circ\text{sin}$ beidseitig / two-sided, DC Anode / anode, $\theta = 180^\circ\text{sin}$ Anode / anode, DC Kathode / cathode, $\theta = 180^\circ\text{sin}$ Kathode / cathode, DC	R_{thJC}	max. 0,0230 $^\circ\text{C/W}$ max. 0,0210 $^\circ\text{C/W}$ max. 0,0395 $^\circ\text{C/W}$ max. 0,0375 $^\circ\text{C/W}$ max. 0,0500 $^\circ\text{C/W}$ max. 0,0480 $^\circ\text{C/W}$
Übergangs-Wärmewiderstand thermal resistance, case to heatsink	<u>Kühlfläche / cooling surface</u> beidseitig / two-sides einseitig / single-sides	R_{thCH}	max. 0,0035 $^\circ\text{C/W}$ max. 0,0070 $^\circ\text{C/W}$
Höchstzulässige Sperrschichttemperatur maximum junction temperature		$T_{vj\ max}$	125 $^\circ\text{C}$
Betriebstemperatur operating temperature		$T_{c\ op}$	-40...+125 $^\circ\text{C}$
Lagertemperatur storage temperature		T_{stg}	-40...+150 $^\circ\text{C}$

Mechanische Eigenschaften / Mechanical properties

Gehäuse, siehe Anlage case, see annex			Seite 3 page 3
Si-Element mit Druckkontakt Si-pellet with pressure contact			
Anpresskraft clamping force		F	16...32 kN
Steueranschlüsse control terminals	Gate (flat) Gate (round, based on AMP 60598) Kathode / cathode		A 2,8x0,5 mm \varnothing 1,5 mm A 4,8x0,5 mm
Gewicht weight		G	typ. 600 g
Kriechstrecke creepage distance			20 mm
Schwingfestigkeit vibration resistance	f = 50 Hz		50 m/s^2

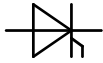

Netz-Thyristor
Phase Control Thyristor

T1190N

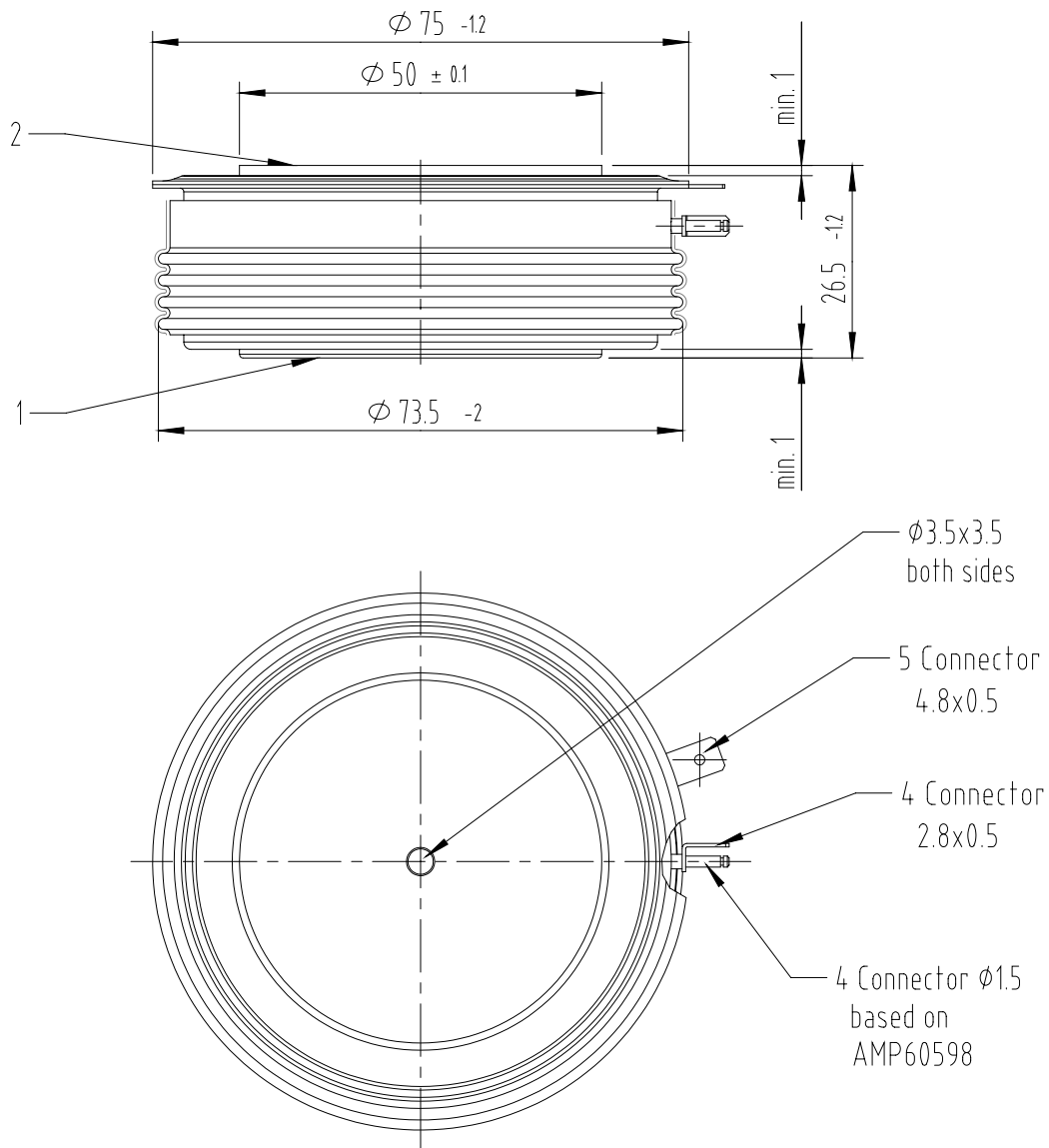

strike distance: 15mm
creepage distance: 20mm

overall height based on contact pressure

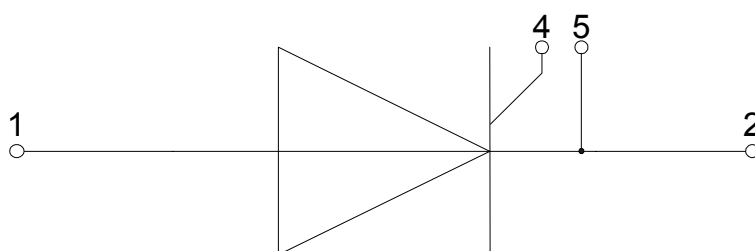

- 1:** Anode / Anode
- 2:** Kathode / Cathode
- 4:** Gate
- 5:** Hilfskathode/
Auxiliary Cathode



Netz-Thyristor
Phase Control Thyristor

T1190N

Analytische Elemente des transienten Wärmewiderstandes Z_{thJC} für DC
Analytical elements of transient thermal impedance Z_{thJC} for DC

Kühlung / Cooling	Pos. n	1	2	3	4	5	6	7
beidseitig two-sided	R_{thn} [°C/W]	0,00113	0,00210	0,00229	0,00703	0,00845	-	-
	τ_n [s]	0,00189	0,00650	0,04560	0,23000	1,13400	-	-
anodenseitig anode-sided	R_{thn} [°C/W]	0,00066	0,00291	0,00370	0,00783	0,02240	-	-
	τ_n [s]	0,00138	0,00614	0,07650	0,37400	6,66000	-	-
kathodenseitig cathode-sided	R_{thn} [°C/W]	0,00127	0,00260	0,00623	0,00460	0,03330	-	-
	τ_n [s]	0,00201	0,00843	0,12600	0,57000	7,83000	-	-

Analytische Funktion / Analytical function:

$$Z_{thJC} = \sum_{n=1}^{n_{max}} R_{thn} \left(1 - e^{-\frac{t}{\tau_n}} \right)$$

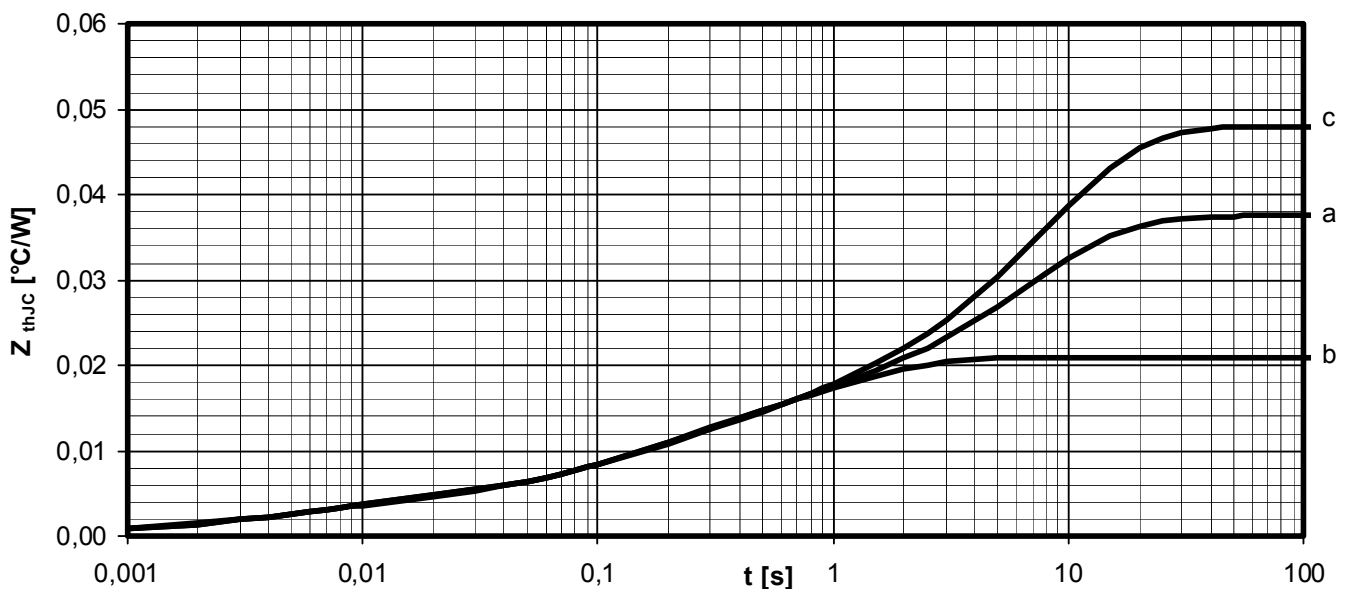

Transient innerer Wärmewiderstand für DC / Transient thermal impedance for DC
 $Z_{thJC} = f(t)$

- a - Anodenseitige Kühlung / Anode-sided cooling
- b - Beidseitige Kühlung / Two-sided cooling
- c - Kathodenseitige Kühlung / Cathode-sided cooling



Netz-Thyristor
Phase Control Thyristor

T1190N

Erhöhung des $Z_{th DC}$ bei Sinus und Rechteckströmen mit unterschiedlichen Stromflusswinkeln Θ
Rise of $Z_{th DC}$ for sinewave and rectangular current with different current conduction angles Θ

$\Delta Z_{th \Theta rec} / \Delta Z_{th \Theta sin}$

Kühlung / Cooling		$\Theta = 180^\circ$	$\Theta = 120^\circ$	$\Theta = 90^\circ$	$\Theta = 60^\circ$	$\Theta = 30^\circ$
beidseitig two-sided	$\Delta Z_{th \Theta rec}$ [°C/W]	0,00292	0,00489	0,00637	0,00845	0,01154
	$\Delta Z_{th \Theta sin}$ [°C/W]	0,00209	0,00305	0,00435	0,00642	0,01002
anodenseitig anode-sided	$\Delta Z_{th \Theta rec}$ [°C/W]	0,00298	0,00489	0,00630	0,00827	0,01131
	$\Delta Z_{th \Theta sin}$ [°C/W]	0,00220	0,00312	0,00433	0,00625	0,00973
kathodenseitig cathode-sided	$\Delta Z_{th \Theta rec}$ [°C/W]	0,00294	0,00492	0,00639	0,00845	0,01148
	$\Delta Z_{th \Theta sin}$ [°C/W]	0,00214	0,00309	0,00439	0,00645	0,01000

$$Z_{th \Theta rec} = Z_{th DC} + \Delta Z_{th \Theta rec}$$

$$Z_{th \Theta sin} = Z_{th DC} + \Delta Z_{th \Theta sin}$$

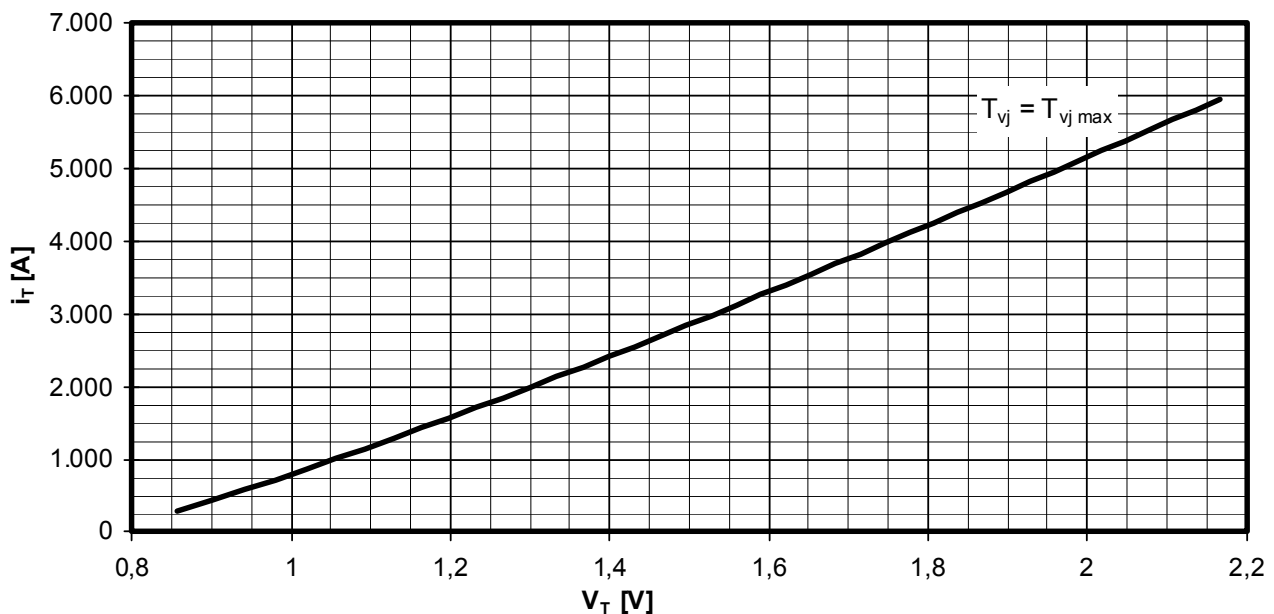

Grenzdurchlasskennlinie / Limiting on-state characteristic $i_T = f(v_T)$

$$T_{vj} = T_{vj max}$$



Netz-Thyristor
Phase Control Thyristor

T1190N

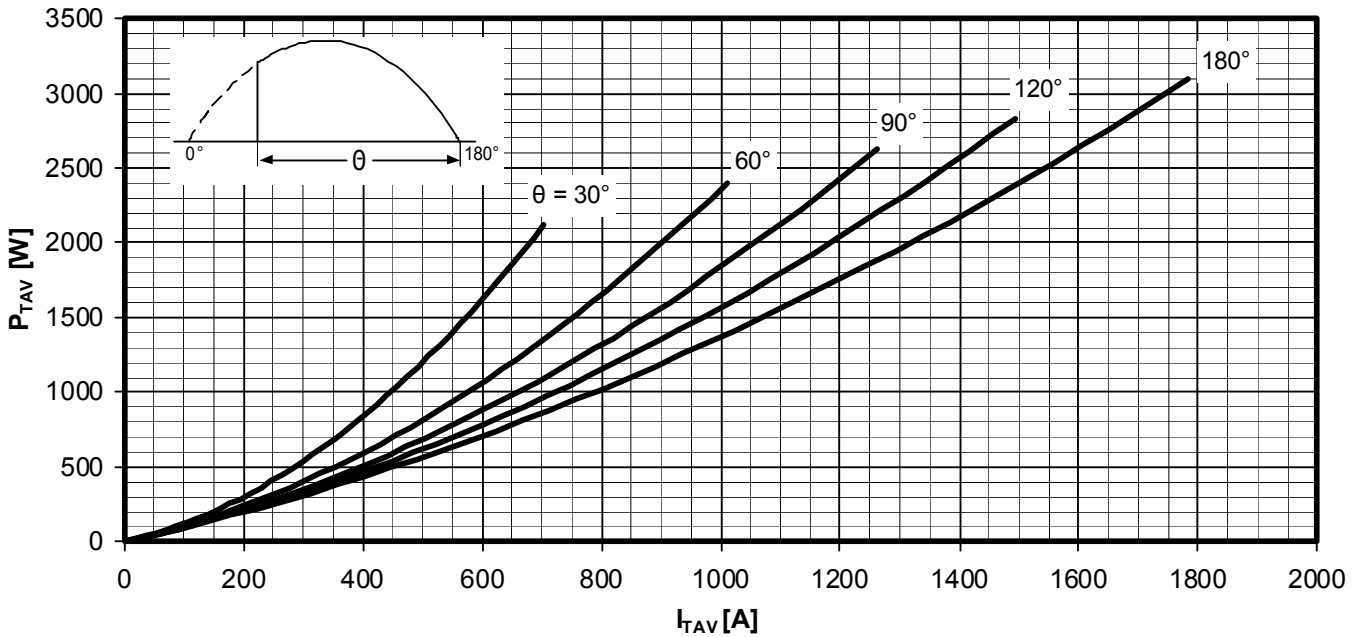

Durchlassverlustleistung / On-state power loss $P_{TAV} = f(I_{TAV})$

Sinusförmiger Strom / Sinusoidal current

Parameter: Stromflusswinkel Θ / Current conduction angle Θ

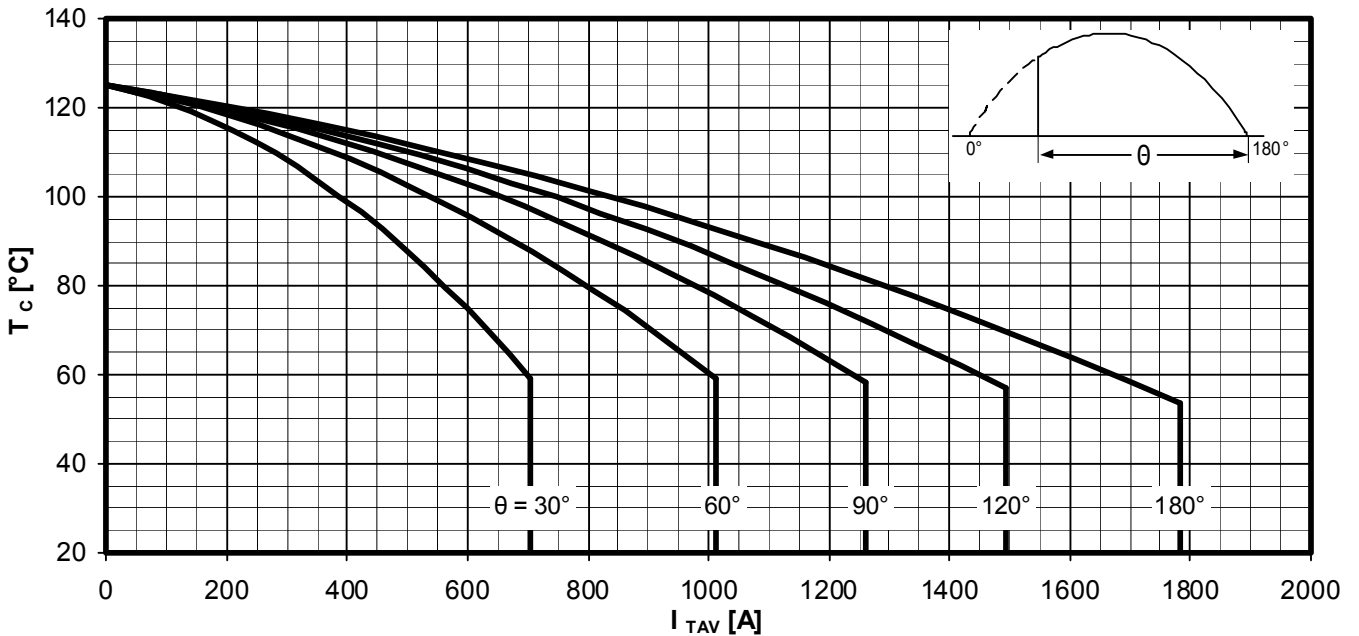

Höchstzulässige Gehäusetemperatur / Maximum allowable case temperature $T_c = f(I_{TAV})$

Sinusförmiger Strom / Sinusoidal current

Beidseitige Kühlung / Two-sided cooling

Parameter: Stromflusswinkel Θ / Current conduction angle Θ



Netz-Thyristor
Phase Control Thyristor

T1190N

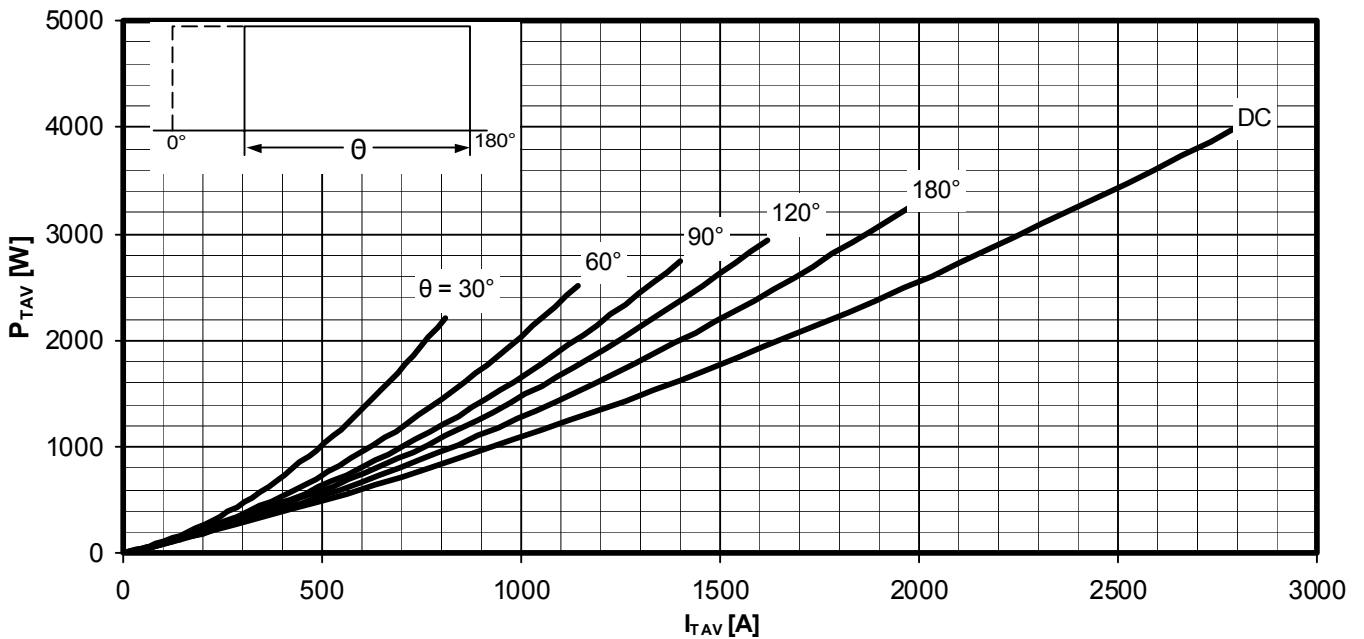

Durchlassverlustleistung / On-state power loss $P_{TAV} = f(I_{TAV})$

Rechteckförmiger Strom / Rectangular current

Parameter: Stromflusswinkel Θ / Current conduction angle Θ

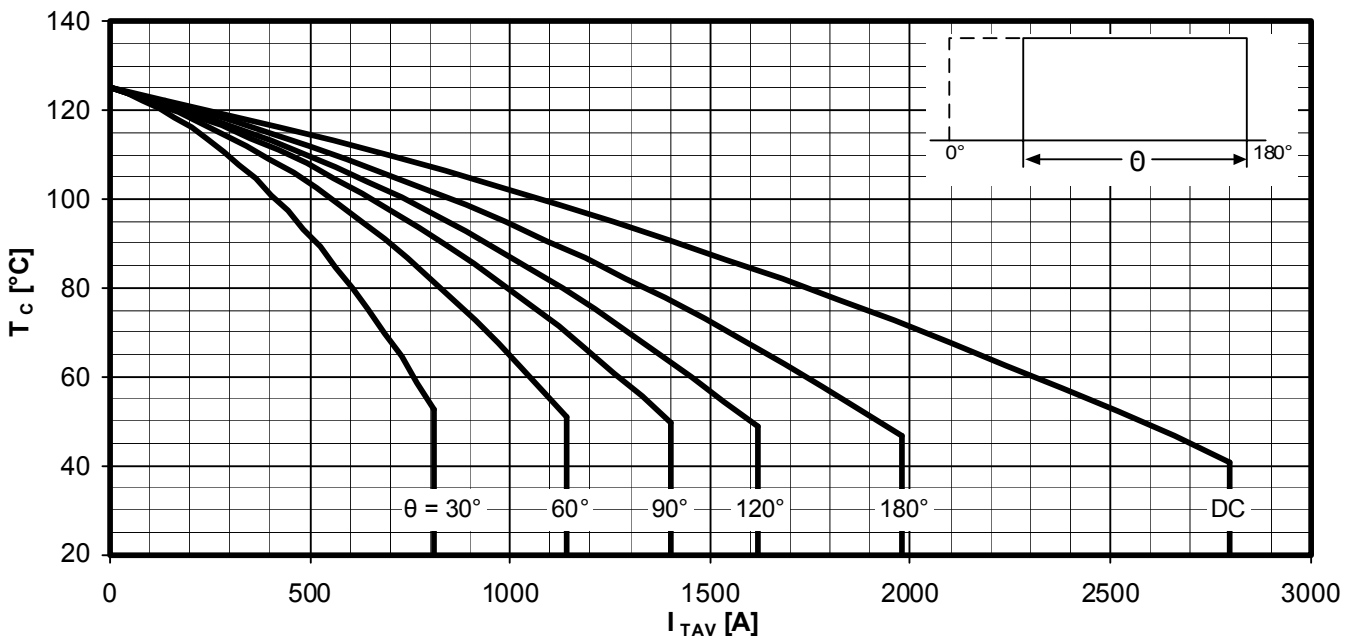

Höchstzulässige Gehäusetemperatur / Maximum allowable case temperature $T_c = f(I_{TAV})$

Rechteckförmiger Strom / Rectangular current

Beidseitige Kühlung / Two-sided cooling

Parameter: Stromflusswinkel Θ / Current conduction angle Θ



Netz-Thyristor
Phase Control Thyristor

T1190N

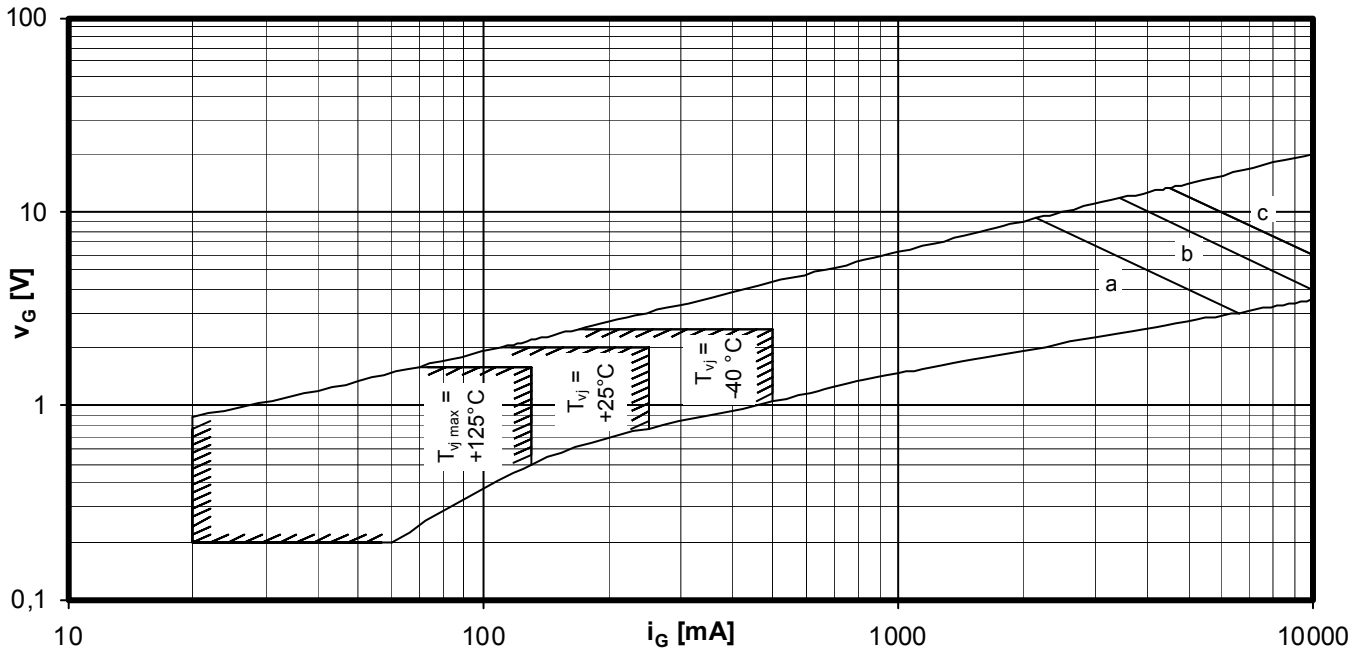

Steuercharakteristik $v_G = f(i_G)$ mit Zündbereichen für $V_D = 12\text{ V}$
 Gate characteristic $v_G = f(i_G)$ with triggering area for $V_D = 12\text{ V}$

Höchstzulässige Spitzensteuerverlustleistung / Maximum rated peak gate power dissipation $P_{GM} = f(t_g)$:

a - 20W / 10ms b - 40W / 1ms c - 60W / 0,5ms

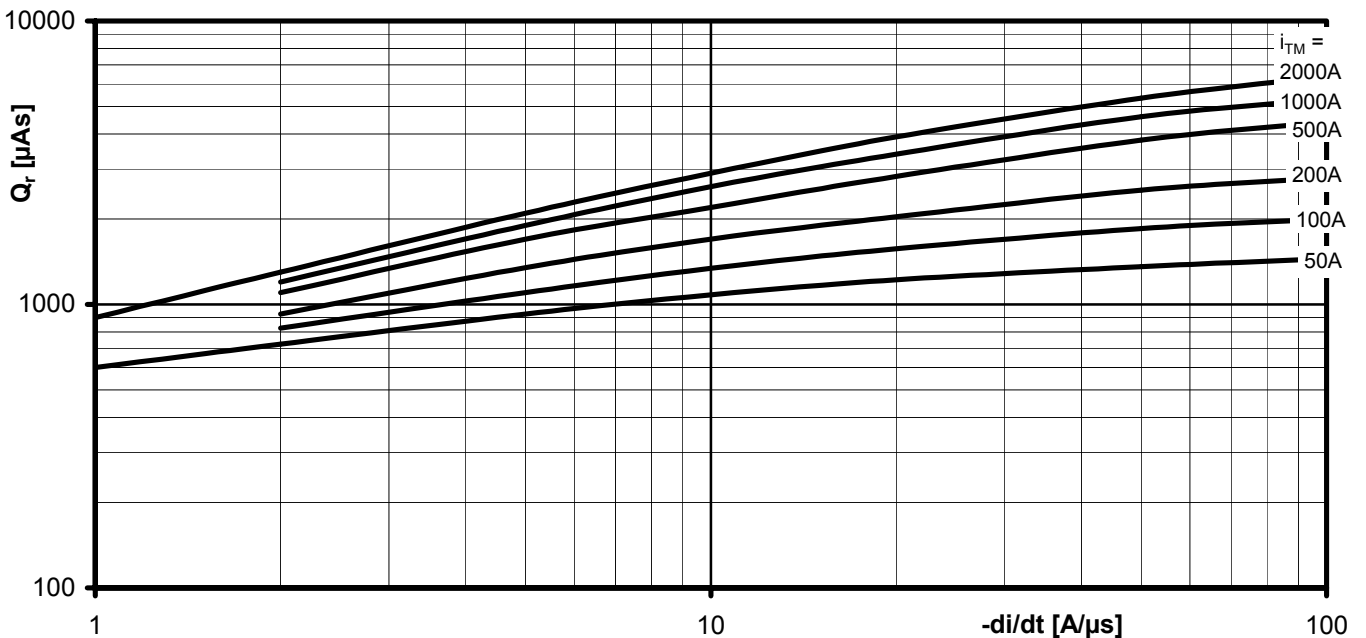

Sperrverzögerungsladung / Recovered charge $Q_r = f(di/dt)$

$T_{vj} = T_{vjmax}, V_R \leq 0,5 V_{RRM}, V_{RM} = 0,8 V_{RRM}$

Parameter: Durchlassstrom / On-state current i_{TM}



Netz-Thyristor
Phase Control Thyristor

T1190N

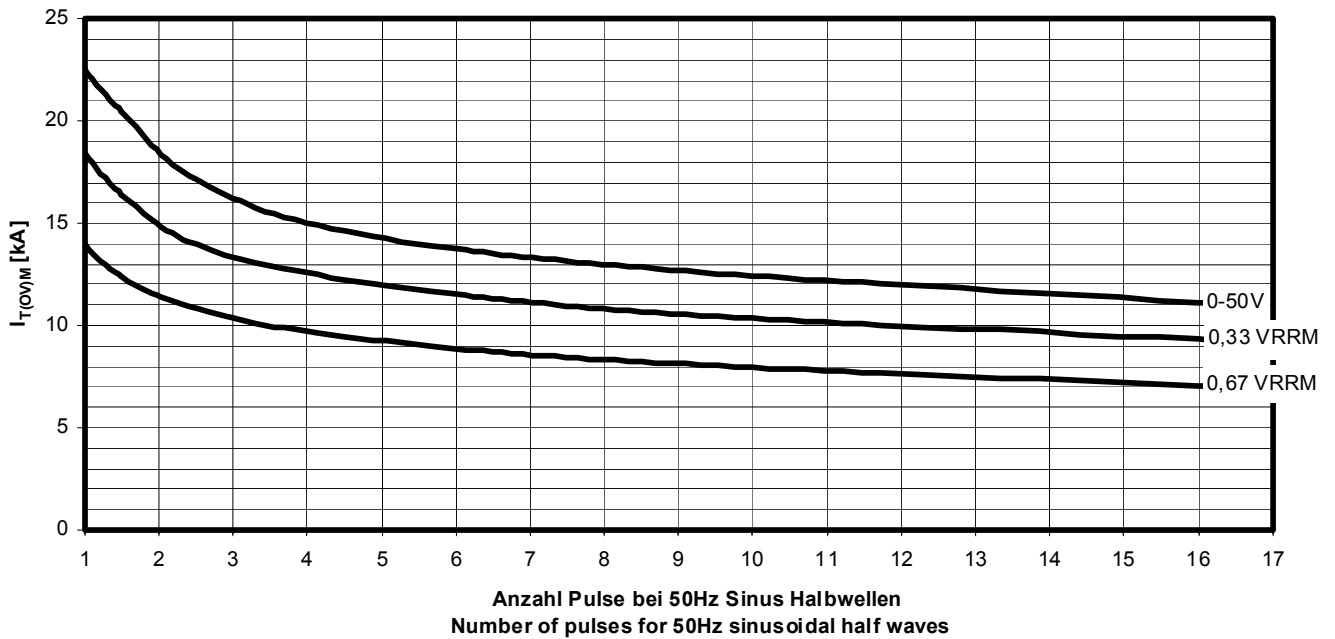

Typische Abhängigkeit des Grenzstromes $I_{T(OV)M}$ von der Anzahl für eine Folge von Sinus Halbwellen bei 50Hz. Parameter: Rückwärtsspannung V_{RM}
 Typical dependency of maximum overload on-state current $I_{T(OV)M}$ as a number of a sequence of sinusoidal half waves at 50Hz. Parameter: peak reverse voltage V_{RM}
 $I_{T(OV)M} = f(\text{pulses}, V_{RM}) ; T_{vj} = T_{vjmax}$